

# POWER RELOCATION Installation Instructions

Ethereal

CELEBRATING  
**75**  
YEARS  
OF INNOVATION

## KIT CONTENTS:

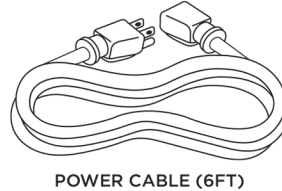
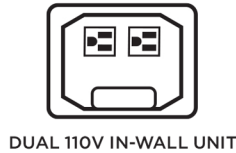
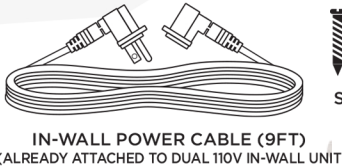
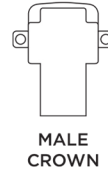
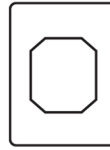
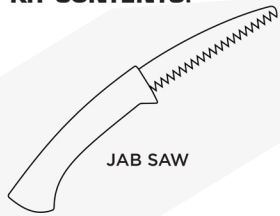

## TOOLS NEEDED:

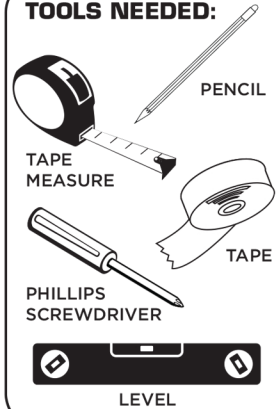

- 1** Check plug size from your TV

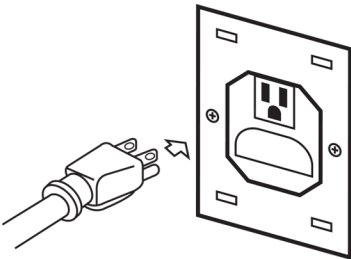

- 2** Center between studs

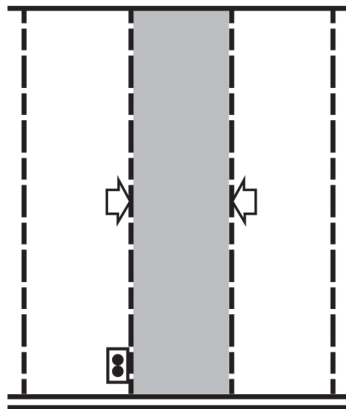

- 3** Measure and mark the location for holes with pencil

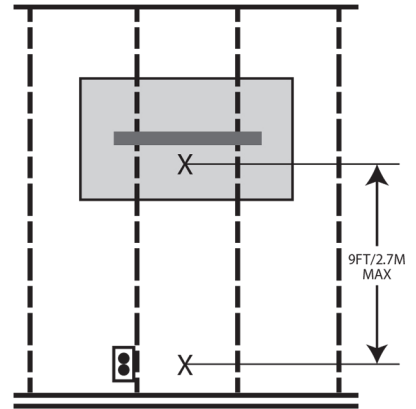

- 4** Cut holes with provided Jab Saw

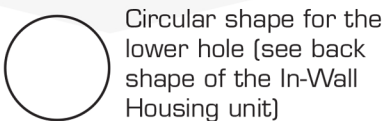
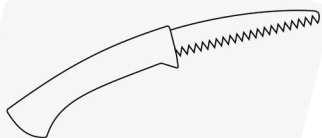
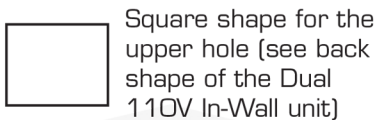

- 5** Use Fish Tape to snake the Dual 110V In-Wall Unit Power Cable into the wall with the **Male Tip at the bottom**. Use tape to secure the Fish Tape if needed.

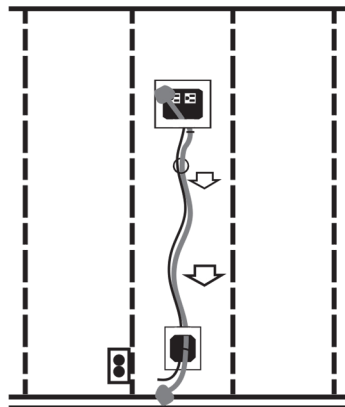

MALE TIP  
FEMALE TIP (ALREADY ATTACHED TO THE Dual 110V IN-WALL UNIT)

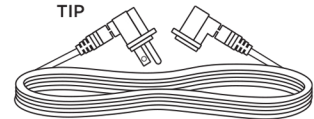

**NOTE: Snake any additional AV connection cables at this time. (Coax cable not included)**



# POWER RELOCATION Installation Instructions

Ethereal

CELEBRATING  
**75**  
YEARS  
OF INNOVATION

**6** At the bottom, insert Male Tip into the back side of the In-Wall Housing unit.

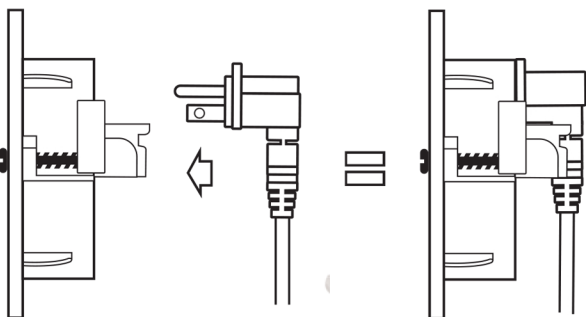

**7** Snap on Male Crown over the Plug Tip and secure with screws.

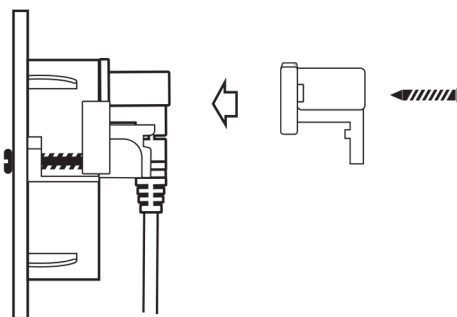

**8** Fold in Dog Ears and slide Housing into wall. Repeat at the bottom with the Male Housing.

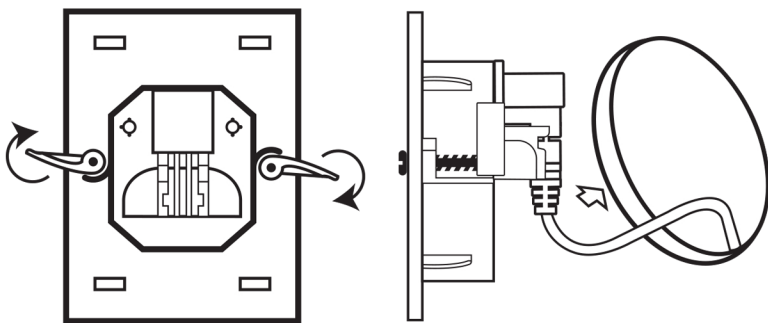

**9** Level and screw Dog Ears until Housing is secure. Repeat at the bottom with the Male Housing.

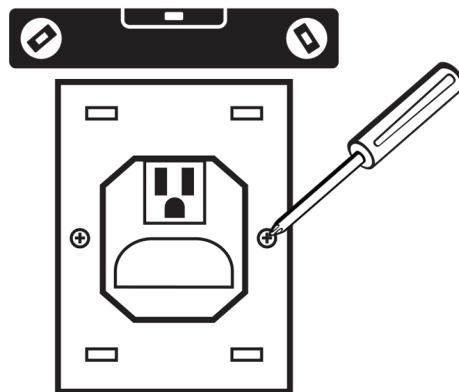

**10** Snap Housing Fascia onto the front of the Housing. Repeat at the bottom with the Male Housing.

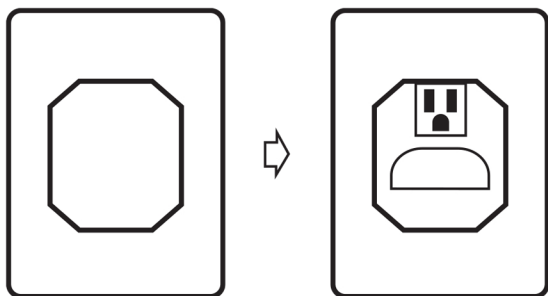

**11** Plug Extension Cord into the bottom device. Installation is now complete.

